

VISUM3





CERAMIC ROOF SOLUTIONS



Single H fire supports that allow the tiles to be fired individually at high temperatures, obtaining perfect definition.



PERFECTION IS TO REACH THE TOP. La Escandella stands once again by the latest technology, heavily investing in a new production line designed to optimize the finish of its products and creating a Premium product range. Discover the new H-Selection line, made for excellence.

H-Selection is the result of applying modern manufacturing processes in H-Cassette to a selection of our products, endowing them with numerous functional and aesthetic advantages and benefits.



High definition on each piece

Individual curing of each tile thanks to support in H. Excellent flatness with no contact points.



Excellent flatness

It provides a perfect definition on each piece, made with gypsum moulds, providing a much finer texture.



Low absorption

Higher resistance to ice and mould formation.



Lifetime warranty

Our 100 years of warranty ensure your peace of mind and demonstrate the quality of our manufacturing process.

visum3

3 in 1 tile

Visum3 is a patented interlocking tile with an innovative triple cambered design that gives the appearance of three plain tiles.

Wide range of colors

Its triple exclusive decoration system offers a broader range in tones and hues, so no two tiles are alike.

Excellent flatness

H-Cassette manufacturing provides a perfect finish to each product.

Double interlocking

The double interlocking -horizontal and vertical- allows the roof to be more watertight, ensuring its impermeability.

Cost reduction

Its large format (11,5 units/m²) and strapping every 6 units, as well as its packaging on pallets of 216 and 288 units, reduce installation costs.



Lower absorption (<5%)

High quality clay together with high firing temperature mean higher resistance to ice and mildew.

Higher resistance

The clay composition together with the perfect pressing allows flexion higher than the required while only weighing 3.6 kg.

TECHNICAL CHARACTERISTICS

Flexural Strength test (EN 538)	Resistance > 1200N
Water Impermeability (EN 539-1)	Complies with level 1
Frost Resistance (EN 539-2)	Complies 150 cycles
Geometric Characteristics (EN 1024)	Flatness / Straightness ≤ 1,5%

Dimensions*	A: 280mm; B: 471mm; C: 35mm A: 11"; B: 18.54"; C: 1.38"
Pieces /m ² - P./sq.	11,5 - 106.7
Weight piece	3,5 kg / 7.7 lbs
Longitudinal fit **	187 mm (+4 mm ; -10 mm) / 7.36" (+0.16; -0.39")
Transversal fit **	435 mm (± 1 mm) / 17.12" (± 0.04")
Units per pallet	216 / 288
Weight per pallet	778 kg (1,715.2 lbs) / 1037 kg (2,286.2 lbs)
Laying	Broken bond

*The tile dimensions indicated in this chart allow a tolerance of approximately 1-2%
**Theoretic value: this should be re-calculated on site with the tiles that are to be used.



La Escandella

100 YEARS

GUARANTEE

ONE TILE CREATES
THE VISUAL EFFECT OF THREE

FINISHES

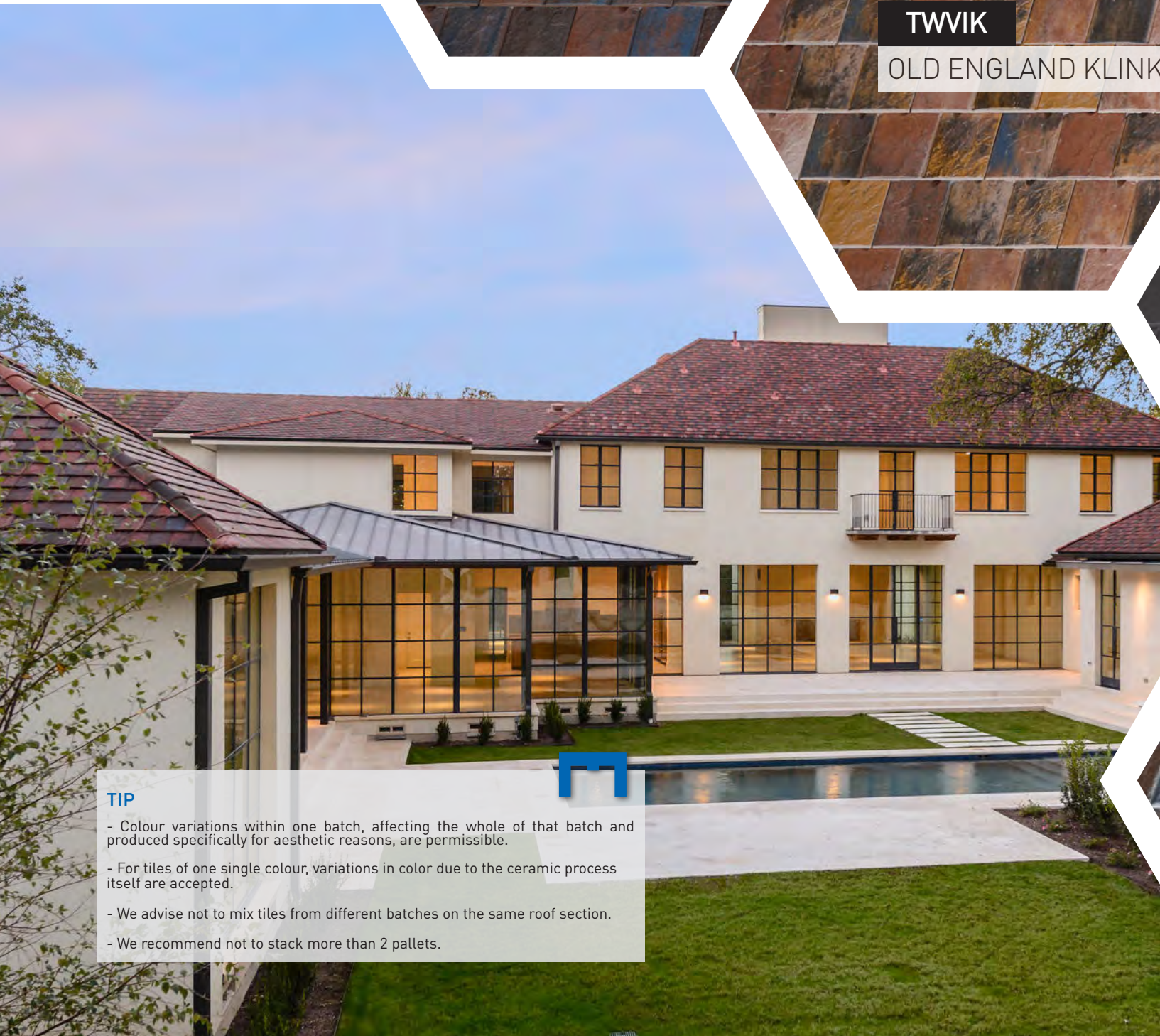

TIP

- Colour variations within one batch, affecting the whole of that batch and produced specifically for aesthetic reasons, are permissible.
- For tiles of one single colour, variations in color due to the ceramic process itself are accepted.
- We advise not to mix tiles from different batches on the same roof section.
- We recommend not to stack more than 2 pallets.

Inspiring Colours

TWRRK

RUSTIC RED KLINKER

TWGIK

IDELLA GREY KLINKER

TWPK

SLATE KLINKER

TWGVK

VERMONT GREY KLINKER



LAI D METHOD

Visum3 roof tile is laid on a discontinuous frame or battens, which will be fixed by building a batten and counter batten deck or by fixing them directly to the frame. The laying of Visum3 roof tile is carried out by broken bond (also referred as cross bond) as follows:

1. The Starter course will begin with a Visum3 Right side start course klinker (Q107*K) (this accesorie includes includes a metallic part to direct the water to a gutter as shown in Fig. 2). Then continue with full tiles Visum3 all the course.
2. The second course will start with the Visum3 right side course (Q99*K) followed by Visum3 Right Half roof tile (Q100*K), creating a cross bond visual effect, with full tiles all the course and ending on the left side with the Visum3 Left Half roof tile (Q102*K) and its Left side course (Q101*K).
3. The process should be repeated alternating steps A and B until reaching the ridge.
4. At top course, beneath ridge line, the excess of Q99*K right side course must be cut, as shown in Fig. 1

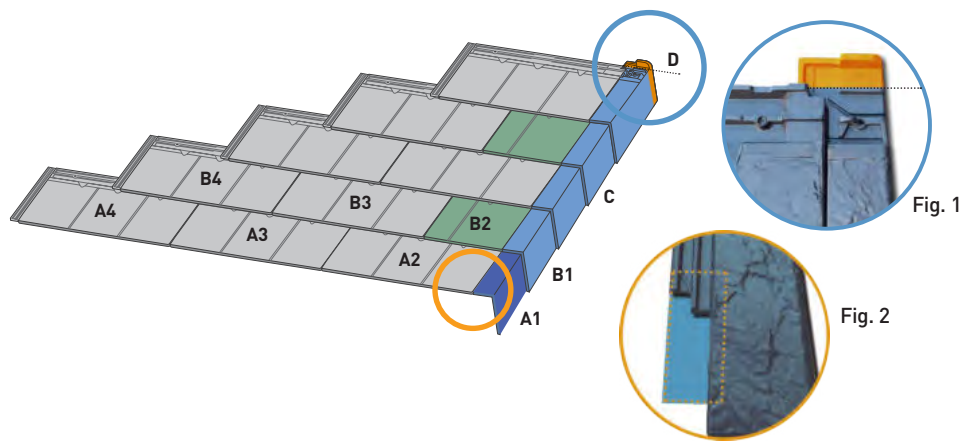

NOTE: A control line between 3 and 5 rows of tiles (maximum) is recommended.

* First course batten should be 20 mm (3/4") higher than all succeeding course battens to provide a vertical alignment and to assure a symmetrical installation

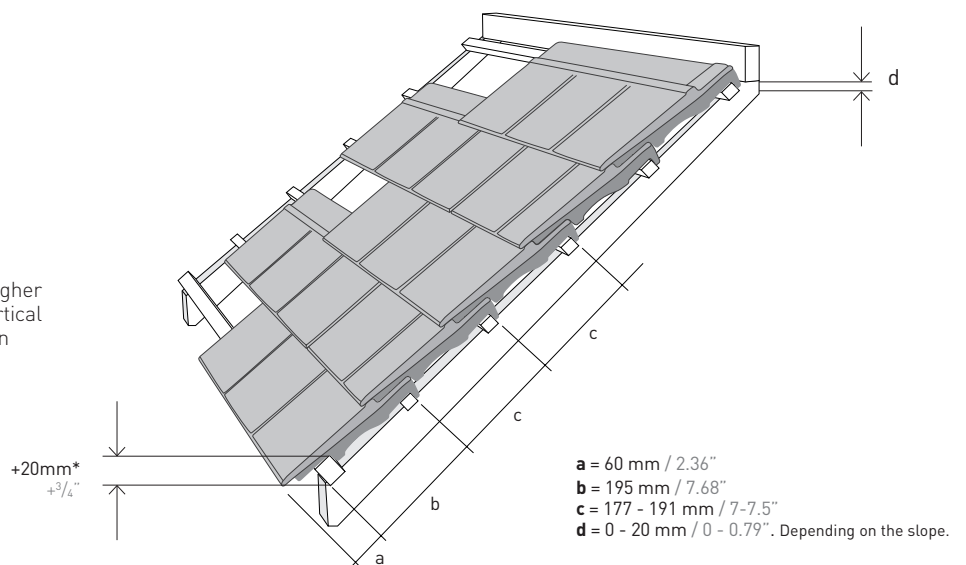

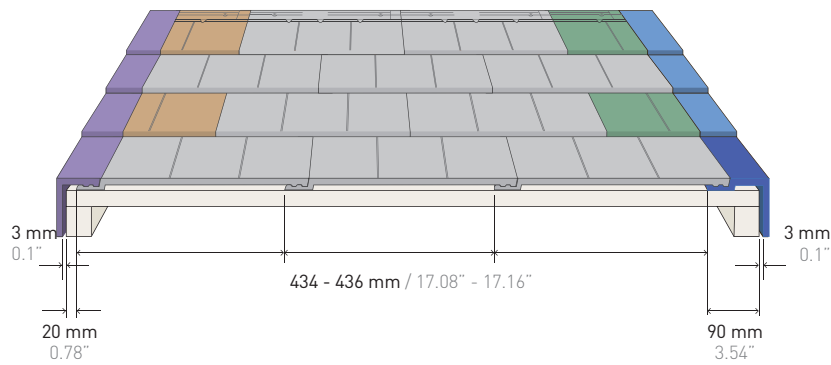

- Visum3 tile
- **Q99*K** Visum3 right side course klinker
- **Q100*K** Visum3 right half roof tile klinker
- **Q101*K** Visum3 left side course klinker
- **Q102*K** Visum3 left half roof tile klinker
- **Q107*K** Visum3 right side start course klinker

TIP

Widthwise or lengthwise laid suggested in the technical catalogues are theoretical. The roofer must calculate the real widthwise or lengthwise laid of the tiles to be installed according to the methods defined in the rules in force in our installation manual.

Tiles are manufactured with natural components and fired at high temperature which generates small dimensional variations.

Download the
**INSTALLATION
MANUAL**



INSTALLATION DETAILS



RIDGE

-Ridge tiles must be installed lap facing away from the prevailing winds, in order to assure water tightness.

-Field tiles at top course should be secured directly either into the deck or top batten with stainless ring screw nails or similar.

-All ridges and hips shall be covered with self adhesive Alu-Roll (CAM01, CAMF1, CAM09, CAMF9) or similar approved breathable waterproof underlayment. Underlayment should be secured over the ridge nailed with non-corrosive roofing nails.

-Apply ridge tiles with a minimum overlapping of 5 cm (2") throughout the ridge line facing away from the prevailing wind-driven rain.

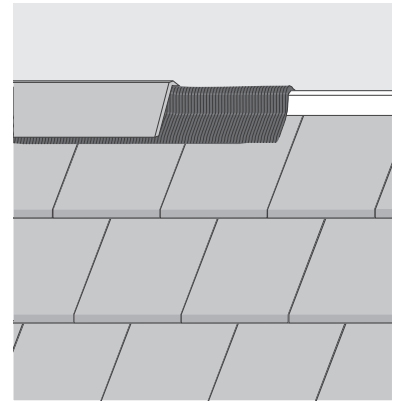

HIP

-Hip tiles must be installed in the same way as in the ridge.

-Field tiles must be miter cut parallel to the hip line and secured.

-All ridges and hips shall be covered with self adhesive Alu-Roll (CAM01, CAMF1, CAM09, CAMF9) or similar approved breathable waterproof underlayment.

- Air should be able to flow through the ridge and hip area. Be sure not to close these off with mortar or similar. Closing them off could result in cracks, peeling off., in freezing and thawing cycles.

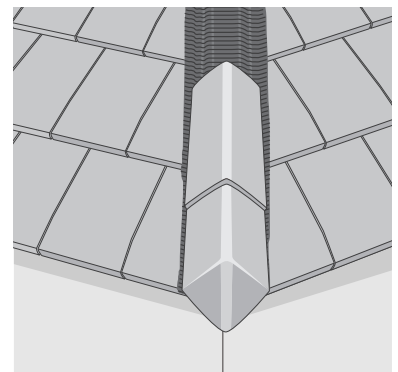

VALLEY

-Both Valley and eave line channel are particularly vulnerable to water migration and leakage. Valleys should have a clear and unobstructed pathway for quick water drainage.

-Install valley battens on each side of the valley crease. Alu-roll Valley (CAM18), or similar approved adhered waterproof valley underlayment, shall be laid vertically up all valleys in addition to other required underlayment that should be fixed by using glue, resin or similar.

-Where valley intersects with ridge line, apply Alu-roll Valley (CAM18), or similar approved underlayment, which should be covered by the ridge tile. Valley should be extended along the eaves to overhang the fascia board by 5cm (2") or over the gutter.

-Tiles should be laid parallel to the valley line, at same relative angle and should overhang the valley battens by at least 10 cm (4").

-Tiles at each side of the valley crease should be laid to provide a minimum 15 cm (6") width gap (tiles should held back minimum 7.5 cm (3") from the center of the valley each way).

-Valley tiles must be secured.

-Proper Valley flashing installation is required to ensure water tightness in order to avoid cracks, peeling off,...

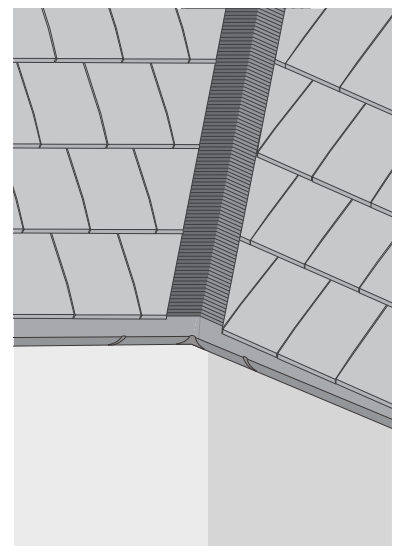

ACCESSORIES

Q02*K | Round ridge / Hip klinker

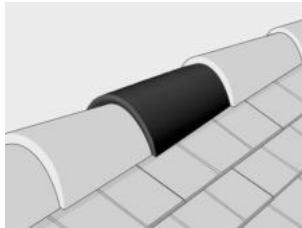
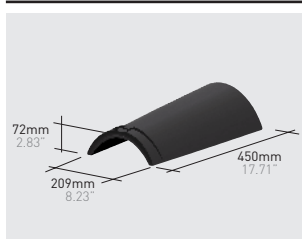

3,400 gr / 7.49 lbs 2.5 u./lm

Q120*K | Angular ridge klinker

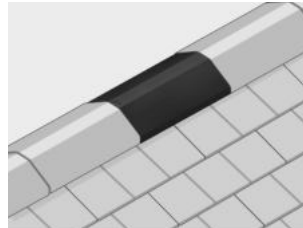
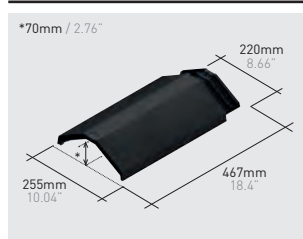

3,500 gr / 7.72 lbs 2.5 u./lm

Q145*K | Ridge 45° klinker

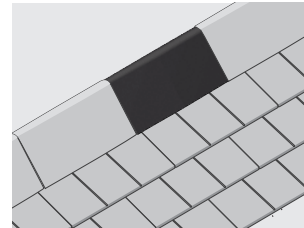
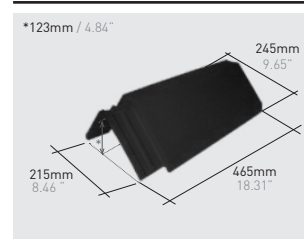

3,850 gr / 8.49 lbs 2.5 u./lm
As wedge must be used **Q120*K**

Q04*K | Round ridge end / Hip starter klinker

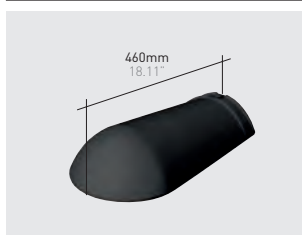

3,300 gr / 7.28 lbs

Q122*K | Angular hip / end ridge klinker

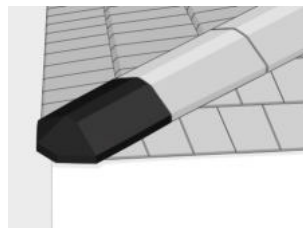
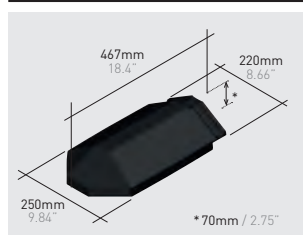

3,300 gr / 7.27 lbs

Q83*K | End cap round ridge klinker

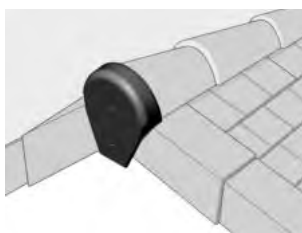
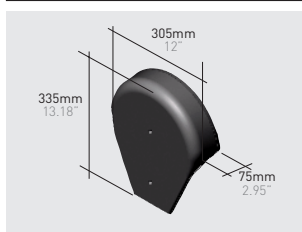

2,500 gr / 5.51 lbs

Q124*K | Angular end cap klinker

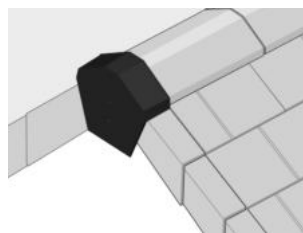
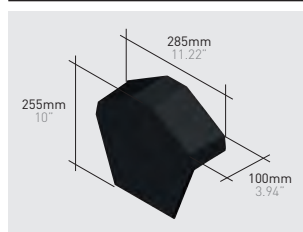

2,180 gr / 4.8 lbs

Q147*K | End cap 45° klinker

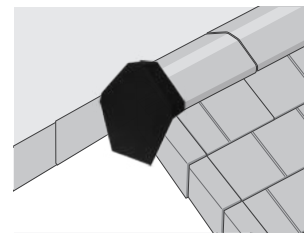
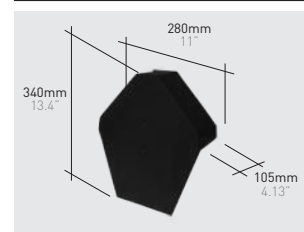

2,700 gr / 5.95 lbs

Q44*K | Round 3 way ridge klinker

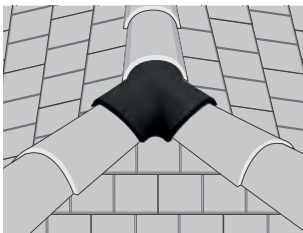
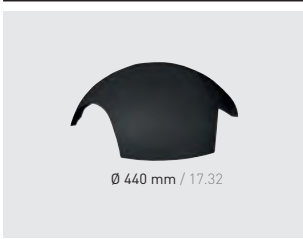

4,600 gr / 10.14 lbs with **Q02*K**

Q45*K | Round 4 way ridge klinker

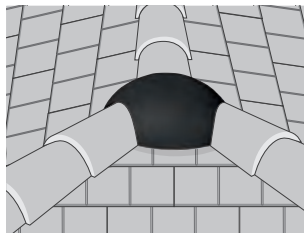

4,100 gr / 9.04 lbs with **Q02*K**

Q55*K | Round 3 way ridge female klinker

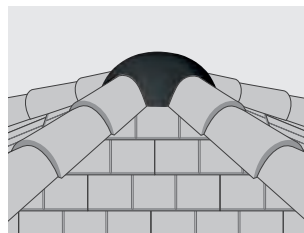
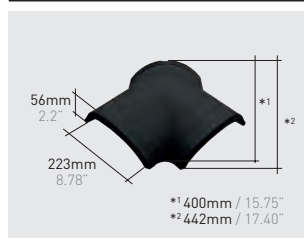

4,100 gr / 9.04 lbs with **Q02*K**

Q146*K | 45° 3 way ridge klinker

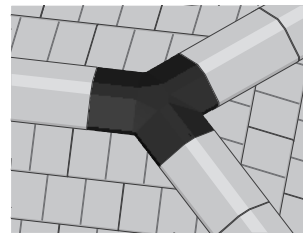
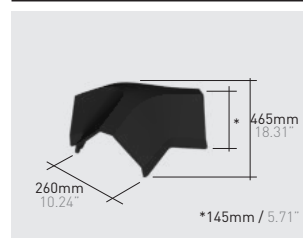

5.000 gr / 11 lbs with **Q145*K**

Q123*K | Angular 3 way ridge klinker

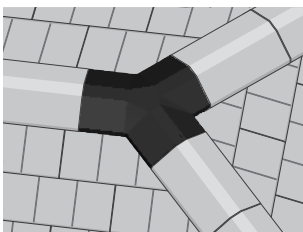
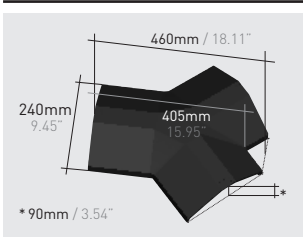

3,720 gr / 8.2 lbs with **Q120*K**

Q96*K | Visum3 ventilation roof tile klinker

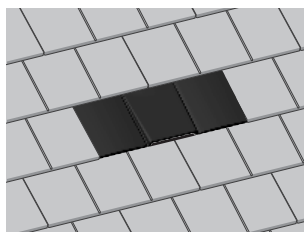
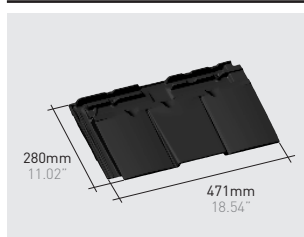

4,200 gr / 9.26 lbs

Q97*K | Visum3 chimney roof tile
CAM87 | Visum3 metal grille chimney roof tile

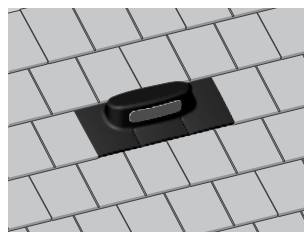
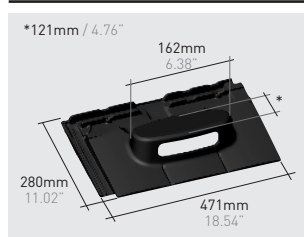

4,000 gr / 8.82 lbs

● **Q99*K** | Visum3 right side course klinker
● **Q107*K** | Visum3 right side start course klinker

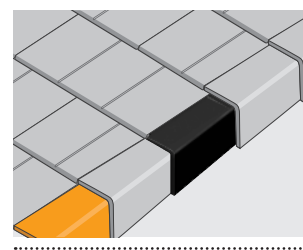
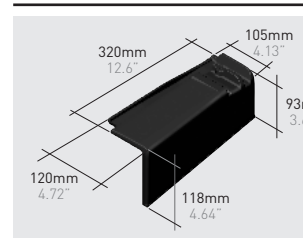

1,800 gr / 3.96 lbs 5.3 u./lm

Q100*K | Visum3 right half roof tile klinker

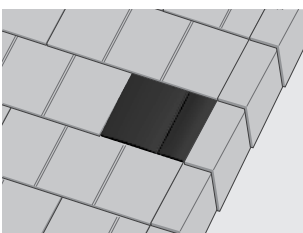

1,900 gr / 4.18 lbs

Q101*K | Visum3 left side course klinker

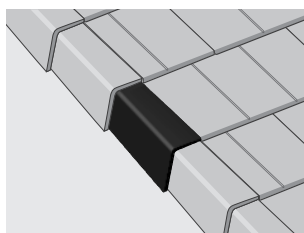
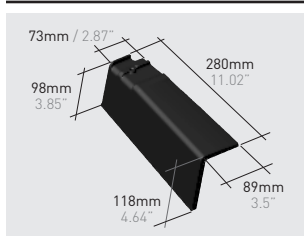

1,250 gr / 2.75 lbs 5.3 u./lm

Q102*K | Visum3 left half roof tile klinker

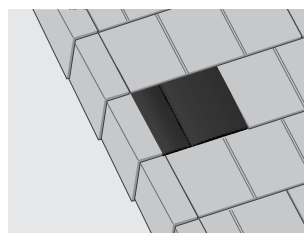

2,000 gr / 4.4 lbs

ROOF ACCESSORIES FOR VENTILATED ROOFS

La Escandella offers a wide range of non-ceramic accessories which help finish off any type of roof. From waterproofing to ventilation, fixing and batten installing, safety implementation and multiple profiles can be found here. (Ask for wider range in last Price List).

CAM01 / CAMF1
Alu-Roll With Micro Cut

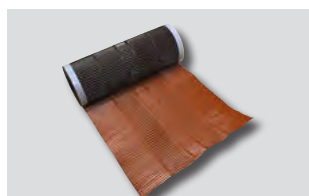

Width: Several sizes
Colours: Red, brown, black.

CAM08 / CAMF8
Alu-Flex

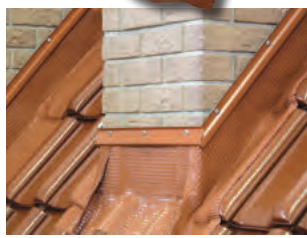
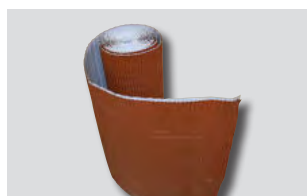

Width: Several sizes
Colours: Red, brown, black.

CAM09 / CAMF9
Alu-Roll Membrane



Width: Several sizes
Colours: Red, brown, black.

CAM18
Alu-Valley Tape



Width: 50 mm / 1.96"
Colours: Red, black, brown.

CAM65 / CAM21 / CAM52 / CAM53
Waterproof membrane



Dimensions: 1,5 m x 50 m / 1.64 yd x 54.68 yd
Weight: several weights.

CAM27NEW / CAM123
Ridge Tile Hook



Colours: Red, brown, black.

CAM05 / CAM010 / CAM51
Ridge Batten Bracket



Dimensions: Several sizes.

CAM14
Eaves Ventilation Comb



Dimensions: 6cm x 1m / 2.36" x 39.37"
Colours: Red, black.

MORE INFO
ON THE
WEBSITE



CAM66
Metal clip clipped with a bumper



CAM62
Eave hook / clip for roof tiles with lace



TECHNICAL INFORMATION

SLOPES / PITCHES

In order to ensure good roof performance, the recommended minimum pitch, determined on the basis of the length of the hip and the climatic conditions of the site; see values in the referral table. For all pitches below the standard recommended minimums, it shall be used a waterproof membrane to ensure the watertight of the roof.

WITHOUT UNDERLAYMENT				WITH UNDERLAYMENT			
Gables	< 6,5m	6,5m-9,5m	9,5m-12m	Gables	< 6,5m	6,5m-9,5m	9,5m-12m
Protected	55% / 29°	60% / 31°	70% / 35°	Protected	45% / 24°	50% / 27°	60% / 31°
Normal	60% / 31°	70% / 35°	80% / 39°	Normal	50% / 27°	60% / 31°	70% / 35°
Exposed	80% / 39°	90% / 42°	100% / 45°	Exposed	70% / 35°	75% / 37°	85% / 40°

PROTECTED LOCATIONS: hollow area which is surrounded by hills that protect the hollow from the winds in all directions..

NORMAL LOCATIONS:: Flat area, plateau with minimal elevation changes.

EXPOSED LOCATIONS: Places open to strong winds, coastal areas (up to 5 km / 3 miles from the shoreline), islands or narrow peninsulas, estuaries or closed bays, narrow valleys, isolated mountains, mountain passes and earthquake zones.

Note: For hips MORE than 12m long (39.4'), a waterproof underlayment on the entire roof deck MUST be applied and the ventilation underneath must be reinforced (check with the manufacturer).

FIXATION

The slope of a roof determines the level of fixation of the tiles required. The fixation of the tiles may be necessary to prevent the sliding of the rooftiles or to prevent their lifting by the effect of the air. **In eaves, right and left side course, lines of ridge, valleys, encounters with vertical walls and other singular points, all the pieces will be fixed.** For all other parts, the level of fixation will depend on the pitch.

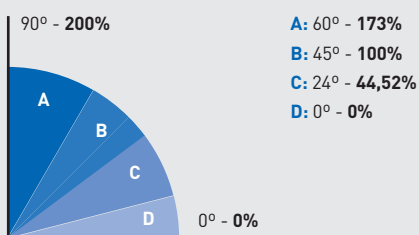

A: Every rooftile should be securely fastened by nailed, screwed, clipped,...

B: Rooftiles will be fixed at least once every **two or three**, depending on the exposure of the roof and the height of the building.

C: The rooftiles shall be fixed at least in the proportion of **one in five** from a horizontal line, initiating fixation by rows alternately and regularly on the battens. In case of high wind exposure, all rooftiles must be fixed.

D: Fixing not recommended due to the design of the roof tile (exit of water in the overlapping ribs does not work at this slope). **Laying in cold areas is prohibited.**

VENTILATION

Ventilation is one of key elements to assure a good hygrothermal behavior of the roof and preservation of the roof structure. The key to a good and well preserved roof is a good ventilated roof. Proper installation of Ventilation tiles combined with ventilated roof can result in energy savings, in a more energy efficient home.

Air should be able to flow through the eave and ridge; be sure not to close these off with cement, mortar or similar. Eave and ridge areas should be protected to help minimize the access of birds and vermin infiltration.

A free flowing ventilation area must be provided through the roof deck. This ventilation should be evenly distributed throughout the roof space to eliminate any dead air space.

La Escandella recommends a minimum of ventilation tile (Q96*K) for every 7 m² (1.32 vent tiles per 100 sq ft.) and with a minimum of 2 ventilation tiles per roof surface, installed on the upper part of the roof.

Using a proper ventilation system is the best way to avoid moisture in a roof, that could cause peeling, cracking and other defects on the tile.

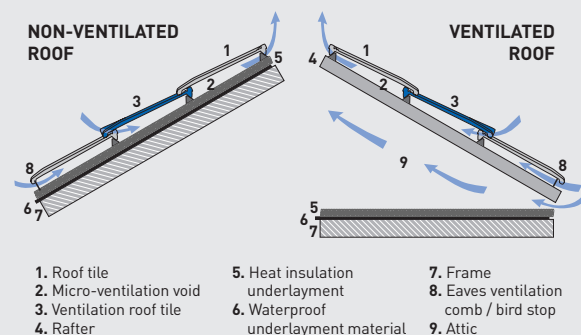



SELECTION
La Escandella



www.laescandella.com



Colour Shall be Harmonized but clay tiles are a natural product and some shade variations between individual pieces enhance their beauty and should be expected. All Tiles should be blended regardless of the number of colours supplied. Colours of the tiles shown in this catalogue can not faithfully reflect the colours of the ceramic tiles.

On their products, La Escandella has right to make changes in dimensions, fittings, weight & units per pallet, without previous notice. For more information, please contact your Sales Representative or our Customer Service.

This catalogue, printed in June 2023, replaces the existing ones.